

BIONIQ EVO ROUND PINHOLE RECESSED

A350216-

base number Color Finishes Finishes Beam Angle
 Temperature (Diamond) (Triangle) Options

- To build a product code in our configurator select the specify button on the base model # product page
- To build a manual product code on this datasheet choose from the options listed below in blue font and add the suffix to the base model #

GENERAL

Series: Bioniq Evo Round Pinhole
 Partner: Prolicht
 Division: Architectural
 Installation: Recessed
 Product Type: Downlight
 Mounting Location: Ceiling
 Light Distribution: Adjustable / Direct

PHYSICAL

Shape: Round
 Diameter (mm): 83
 Diameter (in): 3 1/4
 Height (mm): 100
 Depth (mm): 105
 Height (in): 4
 Depth (in): 4 1/8
 Ceiling Thickness (mm): 2 - 20
 Ceiling Thickness (in): 1/16 - 1 1/8
 Weight (kg): 0.4
 Fixture Finish: SSR / BKV / CWI / CRY / HAB / UFT / ITA / RUA / FTG / MYG / LOD / PUS / FRO / FUP / KIA / POP / BLS / SPG / MEY / GOH / CHC / COM / ABZ / JAG / OBR / MOS / ROR
 Fixture Material: Extruded Aluminum
 Cut-out Measurements: Ø 75mm/2 15/16"

ELECTRICAL

Lamp Type: LED (Zhaga Standard)
 Input Wattage (W): 12.8
 Total Output Wattage (W): 11.8
 Dimming: Non-dimming / DALI Dimming / MATTER Dimming
 Driver Included: No
 Driver Location: Remote
 Driver Type: Constant Current - Universal
 Driver Class: Class 2
 Constant Current (MA): 350mA
 Upon Request: 0-10V Dimming / Phase Dimming

LED

Color Temperature (°K): 2400 / 2700 / 3000 / 3500 / 4000
 Max. Delivered Lumen (lm): Max 951
 Nominal Lumen (lm): 2006
 CRI: >90 CRI
 Efficiency (%): 74.1
 Lamp Life (hrs): 50000

OPTICAL

Beam Angle: 20 / 26 / 32
 Adjustability: Rotational 350° / Tilt 30°

RATINGS AND CERTIFICATIONS

Certified By: Certified for North American Standards
 IP rating: IP65
 Glare Rating: ≤ 10

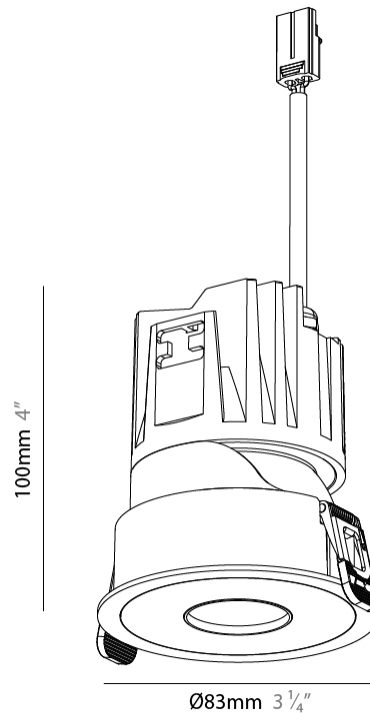
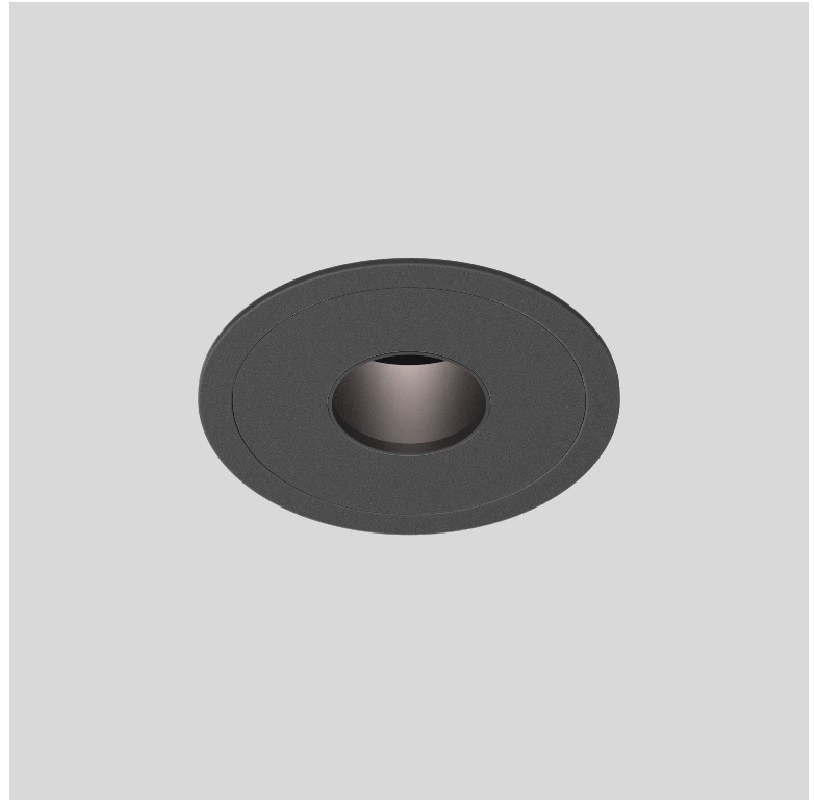

BIONIQ EVO ROUND PINHOLE RECESSED

A350216-

PROJECT	_____
TYPE	_____
SPECIFIER	_____
QUANTITY	_____
DATE	_____

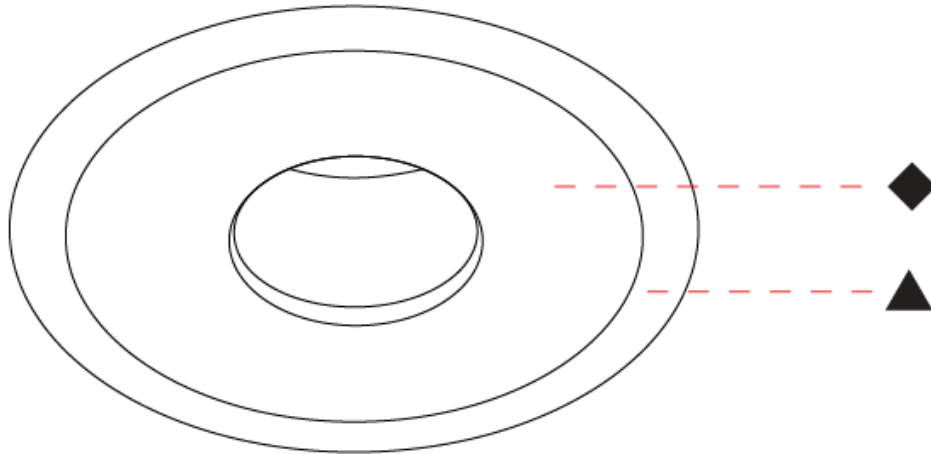

BIONIQ EVO ROUND PINHOLE RECESSED

A350217-

base number Color Finish Beam Angle
 Temperature Options Options

- To build a product code in our configurator select the specify button on the base model # product page
- To build a manual product code on this datasheet choose from the options listed below in blue font and add the suffix to the base model #

GENERAL

Series: Bioniq Evo Round Pinhole
 Partner: Prolicht
 Division: Architectural
 Installation: Recessed
 Product Type: Downlight
 Mounting Location: Ceiling
 Light Distribution: Adjustable / Direct

PHYSICAL

Shape: Round
 Diameter (mm): 83
 Diameter (in): 3 1/4
 Height (mm): 100
 Depth (mm): 105
 Height (in): 4
 Depth (in): 4 1/8
 Ceiling Thickness (mm): 2 - 20
 Ceiling Thickness (in): 1/16 - 1 1/8
 Weight (kg): 0.4
 Fixture Finish: [BLK / WHI](#)
 Fixture Material: Extruded Aluminum
 Cut-out Measurements: Dia. 75mm/2 15/16"

ELECTRICAL

Lamp Type: LED (Zhaga Standard)
 Input Wattage (W): 12.8
 Total Output Wattage (W): 11.8
 Dimming: Non-dimming / DALI Dimming / MATTER Dimming
 Driver Included: No
 Driver Location: Remote
 Driver Type: Constant Current - Universal
 Driver Class: Class 2
 Constant Current (MA): 350mA
 Upon Request: 0-10V Dimming / Phase Dimming

LED

Color Temperature (°K): [2400 / 2700 / 3000 / 3500 / 4000](#)
 Max. Delivered Lumen (lm): Max 951
 Nominal Lumen (lm): 2006
 CRI: >90 CRI
 Efficiency (%): 74.1
 Lamp Life (hrs): 50000

OPTICAL

Beam Angle: [20 / 26 / 32](#)
 Adjustability: Rotational 350° / Tilt 30°

RATINGS AND CERTIFICATIONS

Certified By: Certified for North American Standards
 IP rating: IP65
 Glare Rating: ≤ 10

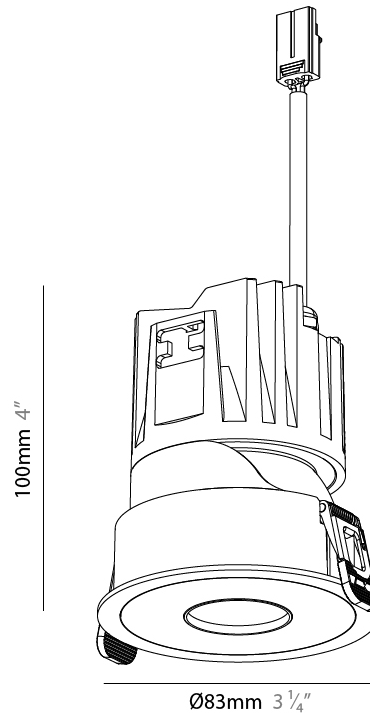
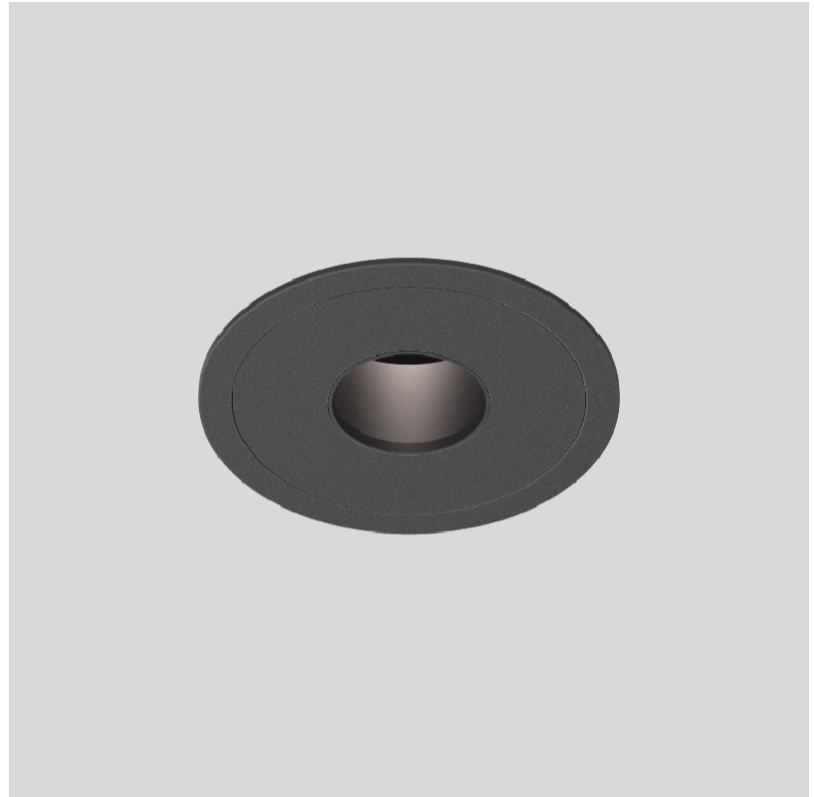

BIONIQ EVO ROUND PINHOLE RECESSED

A350217-

PROJECT	_____
TYPE	_____
SPECIFIER	_____
QUANTITY	_____
DATE	_____

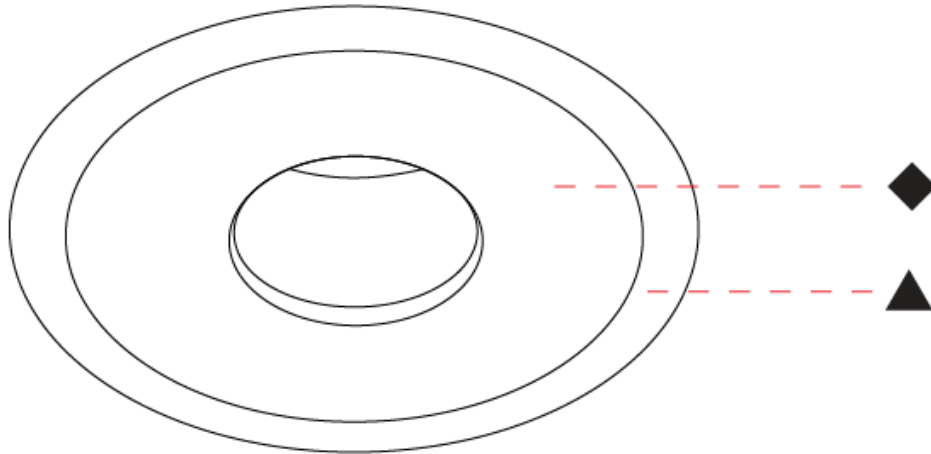

PROJECT	
TYPE	
SPECIFIER	
QUANTITY	
DATE	

BIONIQ EVO ROUND PINHOLE RECESSED

A350218-

base number	Color Temperature	Finishes (Diamond)	Finishes (Triangle)
-------------	----------------------	-----------------------	------------------------

- To build a product code in our configurator select the specify button on the base model # product page
- To build a manual product code on this datasheet choose from the options listed below in blue font and add the suffix to the base model #

GENERAL

Series: Bioniq Evo Round Pinhole
Partner: Prolicht
Division: Architectural
Installation: Recessed
Product Type: Downlight
Mounting Location: Ceiling
Light Distribution: Adjustable / Direct

PHYSICAL

Shape: Round
Diameter (mm): 83
Diameter (in): 3 1/4
Height (mm): 100
Depth (mm): 105
Height (in): 4
Depth (in): 4 1/8
Ceiling Thickness (mm): 2 - 20
Ceiling Thickness (in): 1/16 - 1 1/8
Weight (kg): 0.4
Fixture Finish: SSR / BKV / CWI / CRY / HAB / UFT / ITA / RUA / FTG / MYG / LOD / PUS / FRO / FUP / KIA / POP / BLS / SPG / MEY / GOH / CHC / COM / ABZ / JAG / OBR / MOS / ROR
Fixture Material: Extruded Aluminum
Cut-out Measurements: Ø 75mm/2 15/16"

ELECTRICAL

Lamp Type: LED (Zhaga Standard)
Input Wattage (W): 13
Total Output Wattage (W): 11.8
Dimming: Non-dimming / DALI Dimming / MATTER Dimming
Driver Included: No
Driver Location: Remote
Driver Type: Constant Current - Universal
Driver Class: Class 2
Constant Current (MA): 350mA
Upon Request: 0-10V Dimming / Phase Dimming

LED

Color Temperature (°K): 2400 / 2700 / 3000 / 3500 / 4000
Max. Delivered Lumen (lm): Max 698
Nominal Lumen (lm): Max 1231
CRI: >90 CRI
Efficiency (%): 53.8
Lamp Life (hrs): 50000

OPTICAL

Beam Angle: 10
Adjustability: Rotational 350° / Tilt 30°

RATINGS AND CERTIFICATIONS

Certified By: Certified for North American Standards
IP rating: IP65
Glare Rating: ≤ 10

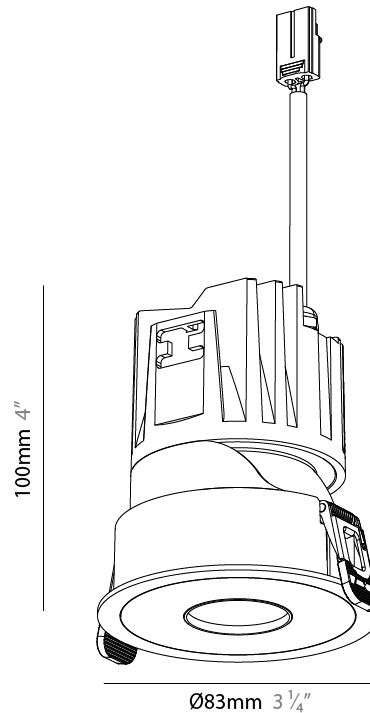
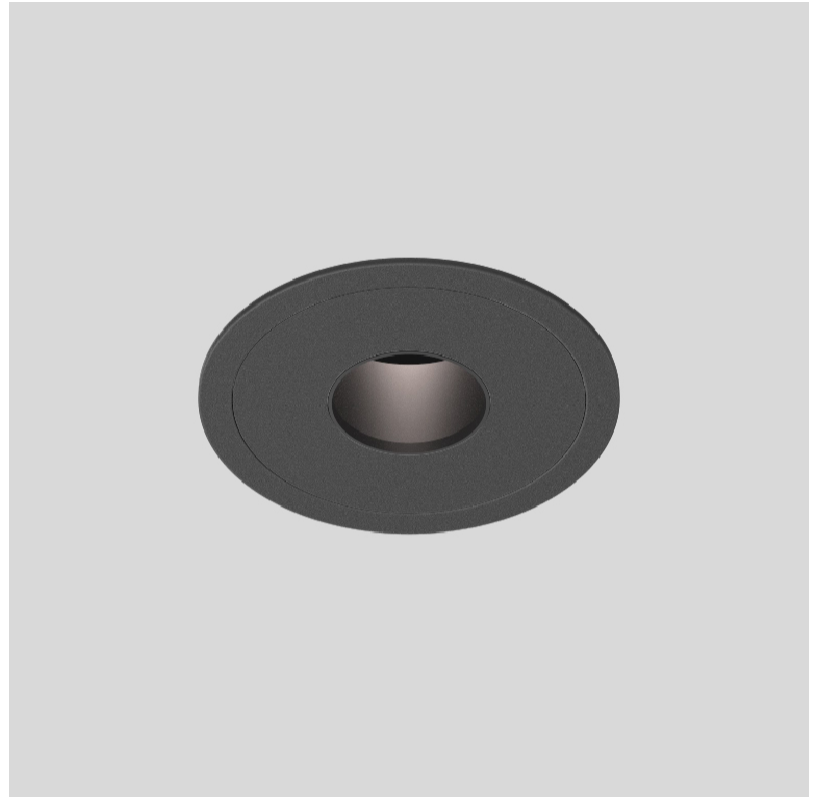

BIONIQ EVO ROUND PINHOLE RECESSED

A350218-

PROJECT	_____
TYPE	_____
SPECIFIER	_____
QUANTITY	_____
DATE	_____

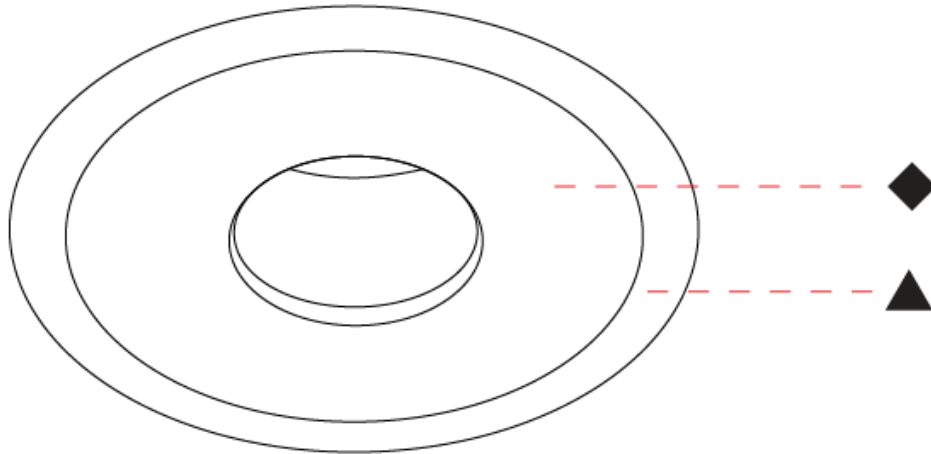

BIONIQ EVO ROUND PINHOLE RECESSED

A350219- _____

base number Color Finish
 Temperature Options

- To build a product code in our configurator select the specify button on the base model # product page
- To build a manual product code on this datasheet choose from the options listed below in blue font and add the suffix to the base model #

GENERAL

Series: Bioniq Evo Round Pinhole
 Partner: Prolicht
 Division: Architectural
 Installation: Recessed
 Product Type: Downlight
 Mounting Location: Ceiling
 Light Distribution: Adjustable / Direct

PHYSICAL

Shape: Round
 Diameter (mm): 83
 Diameter (in): 3 1/4
 Height (mm): 100
 Depth (mm): 105
 Height (in): 4
 Depth (in): 4 1/8
 Ceiling Thickness (mm): 2 - 20
 Ceiling Thickness (in): 1/16 - 1 1/8
 Weight (kg): 0.4
 Fixture Finish: [BLK / WHI](#)
 Fixture Material: Extruded Aluminum
 Cut-out Measurements: Dia. 75mm/2 15/16"

ELECTRICAL

Lamp Type: LED (Zhaga Standard)
 Input Wattage (W): 13
 Total Output Wattage (W): 11.8
 Dimming: Non-dimming / DALI Dimming / MATTER Dimming
 Driver Included: No
 Driver Location: Remote
 Driver Type: Constant Current - Universal
 Driver Class: Class 2
 Constant Current (MA): 350mA
 Upon Request: 0-10V Dimming / Phase Dimming

LED

Color Temperature (°K): [2400 / 2700 / 3000 / 3500 / 4000](#)
 Max. Delivered Lumen (lm): Max 698
 Nominal Lumen (lm): Max 1231
 CRI: >90 CRI
 Efficiency (%): 53.8
 Lamp Life (hrs): 50000

OPTICAL

Beam Angle: 20 / 26 / 32
 Adjustability: Rotational 350° / Tilt 30°

RATINGS AND CERTIFICATIONS

Certified By: Certified for North American Standards
 IP rating: IP65
 Glare Rating: ≤ 10

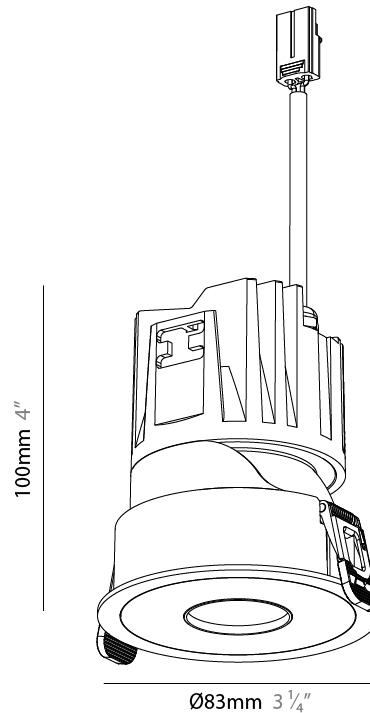
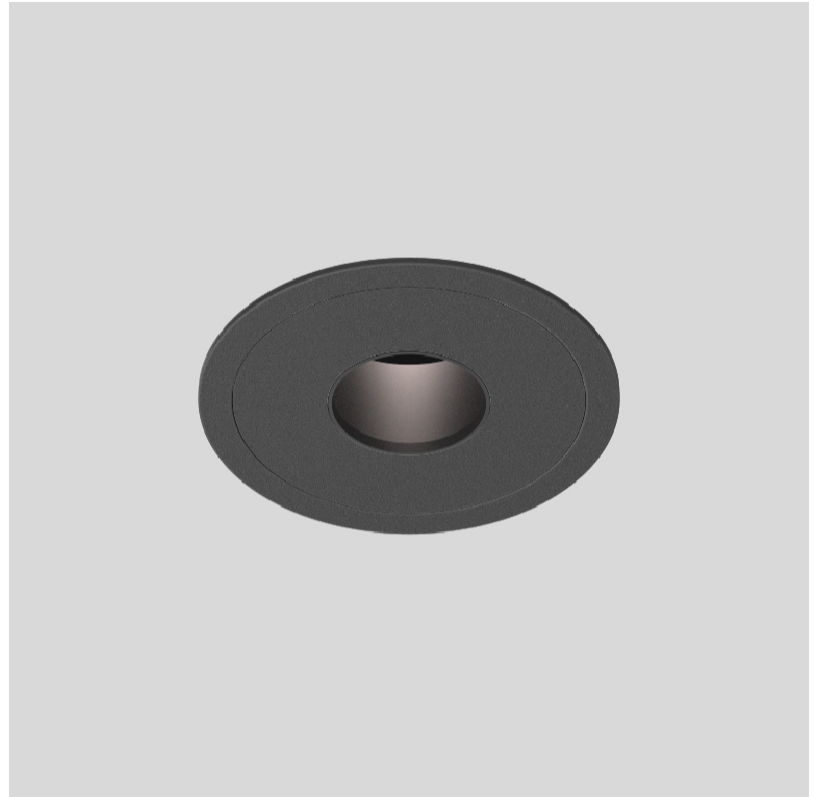

BIONIQ EVO ROUND PINHOLE RECESSED

A350219-

PROJECT	_____
TYPE	_____
SPECIFIER	_____
QUANTITY	_____
DATE	_____

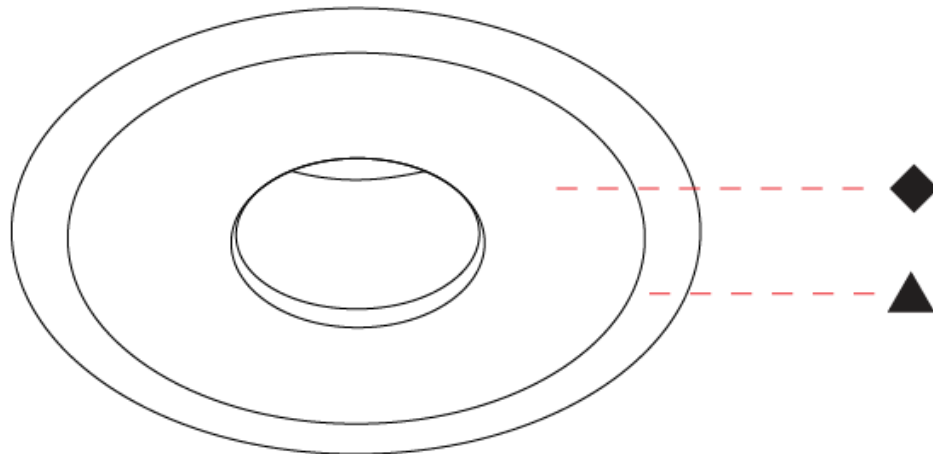

BIONIQ EVO ROUND PINHOLE RECESSED

A350220-

base number Color Temperature Finishes (Diamond) Finishes (Triangle) Beam Angle Options

- To build a product code in our configurator select the specify button on the base model # product page
- To build a manual product code on this datasheet choose from the options listed below in blue font and add the suffix to the base model #

GENERAL

Series: Bioniq Evo Round Pinhole
 Partner: Prolicht
 Division: Architectural
 Installation: Recessed
 Product Type: Downlight
 Mounting Location: Ceiling
 Light Distribution: Adjustable / Direct

PHYSICAL

Shape: Round
 Diameter (mm): 82
 Diameter (in): 3 1/4
 Height (mm): 100
 Depth (mm): 105
 Height (in): 3 15/16
 Depth (in): 4 1/8
 Ceiling Thickness (mm): 2 - 20
 Ceiling Thickness (in): 1/16 - 1 1/8
 Weight (kg): 0.4
 Fixture Finish: [SSR / BKV / CWI / CRY / HAB / UFT / ITA / RUA / FTG / MYG / LOD / PUS / FRO / FUP / KIA / POP / BLS / SPG / MEY / GOH / CHC / COM / ABZ / JAG / OBR / MOS / ROR](#)
 Fixture Material: Extruded Aluminum
 Cut-out Measurements: Dia. 75mm/2 15/16"

ELECTRICAL

Lamp Type: LED (Zhaga Standard)
 Input Wattage (W): 12.3
 Total Output Wattage (W): 10.9
 Dimming: Non-dimming / DALI Dimming / MATTER Dimming
 Driver Included: No
 Driver Location: Remote
 Driver Type: Constant Current - Universal
 Driver Class: Class 2
 Constant Current (MA): 350mA
 Upon Request: 0-10V Dimming / Phase Dimming

LED

Color Temperature (°K): 2700-6500 Tunable White
 Max. Delivered Lumen (lm): Max 709
 Nominal Lumen (lm): Max 1495
 CRI: >90 CRI
 Efficiency (%): 57.5
 Lamp Life (hrs): 50000

OPTICAL

Beam Angle: [20 / 26 / 32](#)
 Adjustability: Rotational 350° / Tilt 30°

RATINGS AND CERTIFICATIONS

Certified By: Certified for North American Standards
 IP rating: IP65
 Glare Rating: ≤ 10

PROJECT	_____
TYPE	_____
SPECIFIER	_____
QUANTITY	_____
DATE	_____

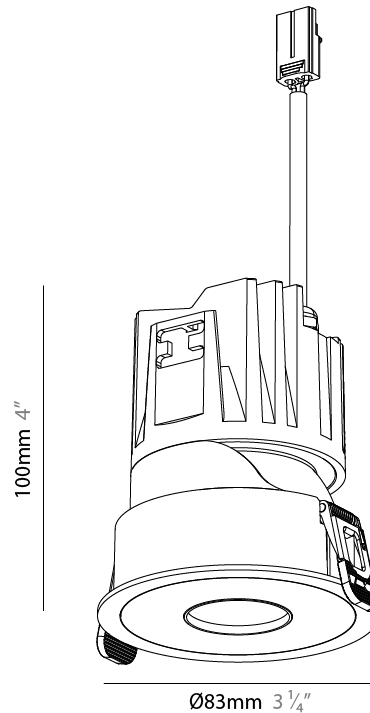
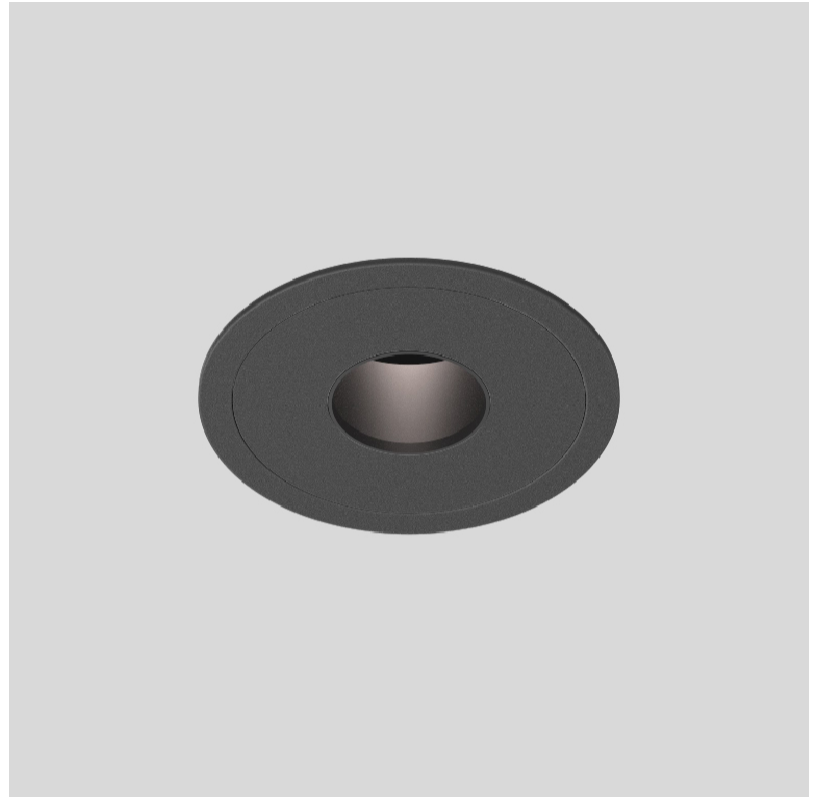

BIONIQ EVO ROUND PINHOLE RECESSED

A350220-

PROJECT	_____
TYPE	_____
SPECIFIER	_____
QUANTITY	_____
DATE	_____

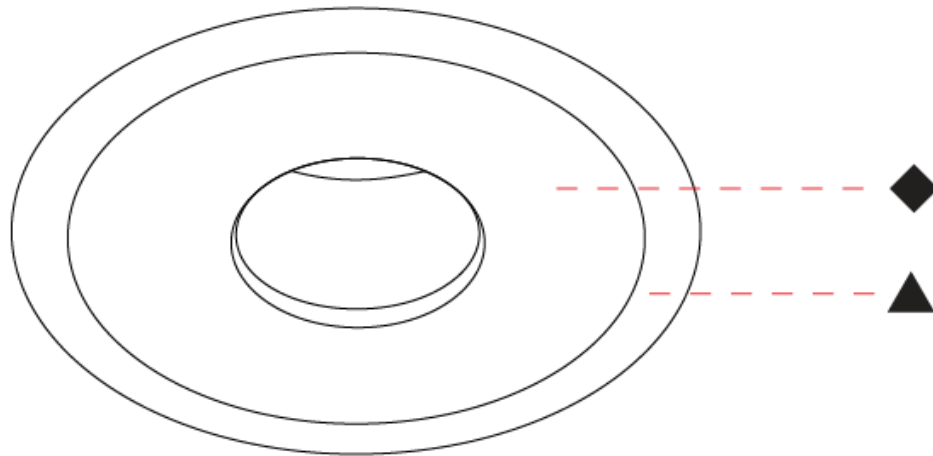

BIONIQ EVO ROUND PINHOLE RECESSED

A350221-

base number Color Finish Beam Angle
 Temperature Options Options

- To build a product code in our configurator select the specify button on the base model # product page
- To build a manual product code on this datasheet choose from the options listed below in blue font and add the suffix to the base model #

GENERAL

Series: Bioniq Evo Round Pinhole
 Partner: Prolicht
 Division: Architectural
 Installation: Recessed
 Product Type: Downlight
 Mounting Location: Ceiling
 Light Distribution: Adjustable / Direct

PHYSICAL

Shape: Round
 Diameter (mm): 83
 Diameter (in): 3 1/4
 Height (mm): 100
 Depth (mm): 105
 Height (in): 4
 Depth (in): 4 1/8
 Ceiling Thickness (mm): 2 - 20
 Ceiling Thickness (in): 1/16 - 1 1/8
 Weight (kg): 0.4
 Fixture Finish: [BLK / WHI](#)
 Fixture Material: Extruded Aluminum
 Cut-out Measurements: Dia. 75mm/2 15/16"

ELECTRICAL

Lamp Type: LED (Zhaga Standard)
 Input Wattage (W): 12.3
 Total Output Wattage (W): 10.9
 Dimming: Non-dimming / DALI Dimming / MATTER Dimming
 Driver Included: No
 Driver Location: Remote
 Driver Type: Constant Current - Universal
 Driver Class: Class 2
 Constant Current (MA): 350mA
 Upon Request: 0-10V Dimming / Phase Dimming

LED

Color Temperature (°K): [2700-6500 Tunable White](#)
 Max. Delivered Lumen (lm): Max 698
 Nominal Lumen (lm): Max 1231
 CRI: >90 CRI
 Efficiency (%): 53.8
 Lamp Life (hrs): 50000

OPTICAL

Beam Angle: [20 / 26 / 32](#)
 Adjustability: Rotational 350° / Tilt 30°

RATINGS AND CERTIFICATIONS

Certified By: Certified for North American Standards
 IP rating: IP65
 Glare Rating: ≤ 10

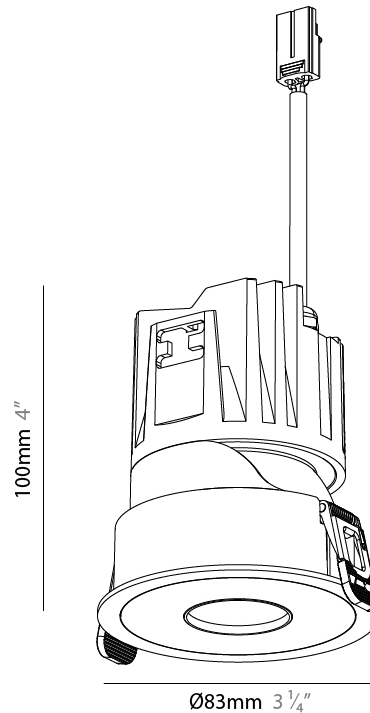

BIONIQ EVO ROUND PINHOLE RECESSED

A350221-

PROJECT

TYPE

SPECIFIER

QUANTITY

DATE

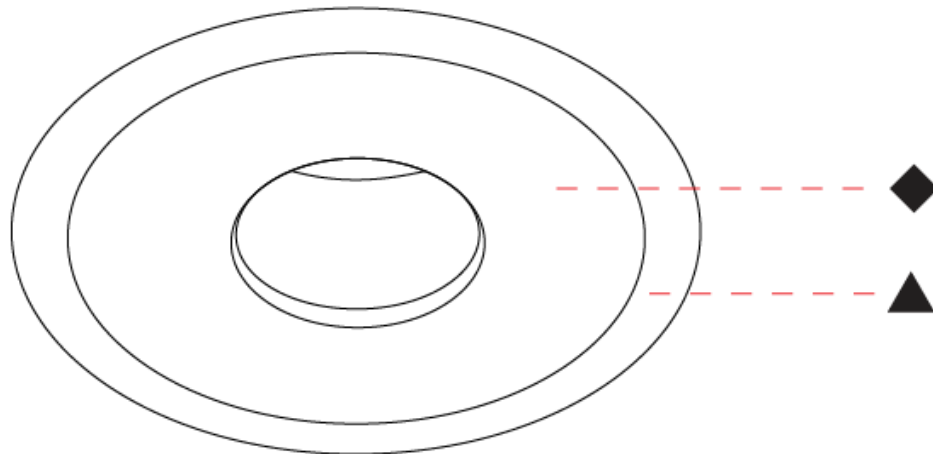

BIONIQ EVO ROUND PINHOLE TRIMLESS

A350222-

base number Color Temperature Finishes (Diamond) Lens Options Beam Angle Options

- To build a product code in our configurator select the specify button on the base model # product page
- To build a manual product code on this datasheet choose from the options listed below in blue font and add the suffix to the base model #

GENERAL

Series: Bioniq Evo Round Pinhole
 Partner: Prolicht
 Division: Architectural
 Installation: Trimless
 Product Type: Downlight
 Mounting Location: Ceiling
 Light Distribution: Adjustable / Direct

PHYSICAL

Shape: Round
 Diameter (mm): 95
 Diameter (in): 3 3/4
 Height (mm): 93
 Depth (mm): 105
 Height (in): 3 5/8
 Depth (in): 4 1/8
 Ceiling Thickness (mm): 10 - 50
 Ceiling Thickness (in): 3/8 - 1 15/16
 Weight (kg): 0.4
 Fixture Finish: [SSR / BKV / CWI / CRY / HAB / UFT / ITA / RUA / FTG / MYG / LOD / PUS / FRO / FUP / KIA / POP / BLS / SPG / MEY / GOH / CHC / COM / ABZ / JAG / OBR / MOS / ROR](#)
 Fixture Material: Extruded Aluminum
 Cut-out Measurements: Dia. 75mm/2 15/16"

ELECTRICAL

Lamp Type: LED (Zhaga Standard)
 Input Wattage (W): 12.8
 Total Output Wattage (W): 11.8
 Dimming: Non-dimming / DALI Dimming / MATTER Dimming
 Driver Included: No
 Driver Location: Remote
 Driver Type: Constant Current - Universal
 Driver Class: Class 2
 Constant Current (MA): 350mA
 Upon Request: 0-10V Dimming / Phase Dimming

LED

Color Temperature (°K): [2400 / 2700 / 3000 / 3500 / 4000](#)
 Max. Delivered Lumen (lm): Max 951
 Nominal Lumen (lm): 2006
 CRI: >90 CRI
 Efficiency (%): 74.1
 Lamp Life (hrs): 50000

OPTICAL

Beam Angle: [20 / 26 / 32](#)
 Adjustability: Rotational 350° / Tilt 30°

RATINGS AND CERTIFICATIONS

Certified By: Certified for North American Standards
 IP rating: IP65
 Glare Rating: ≤ 10

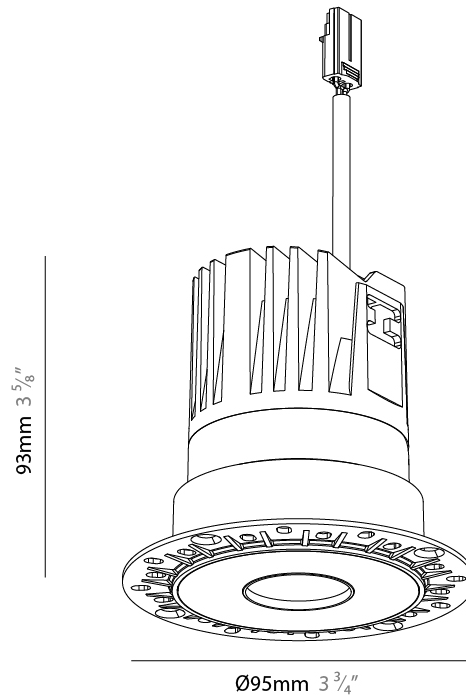
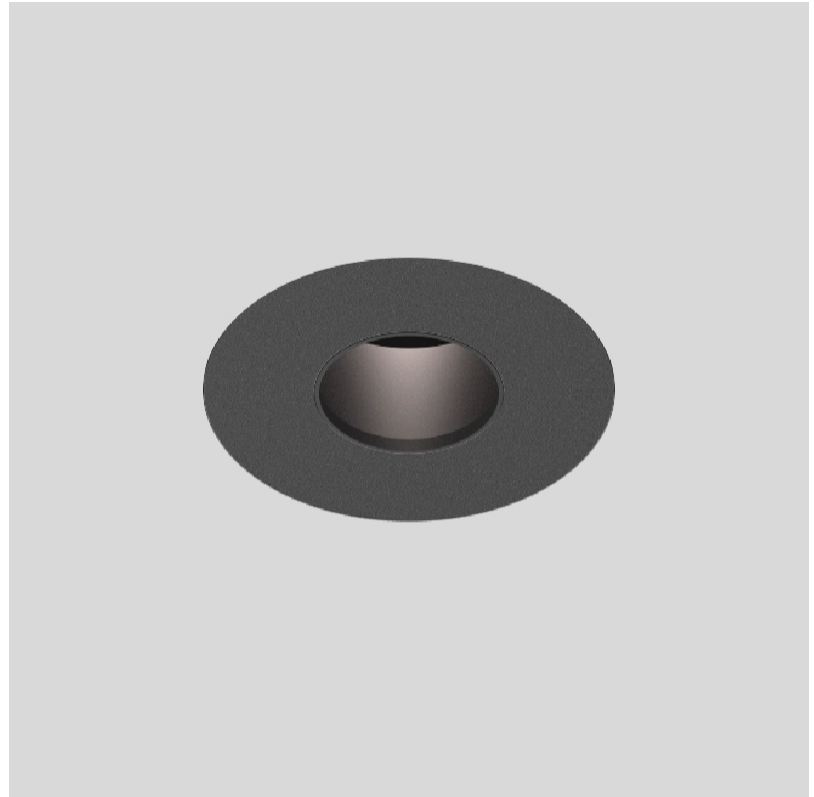

BIONIQ EVO ROUND PINHOLE TRIMLESS

A350222-

PROJECT	_____
TYPE	_____
SPECIFIER	_____
QUANTITY	_____
DATE	_____

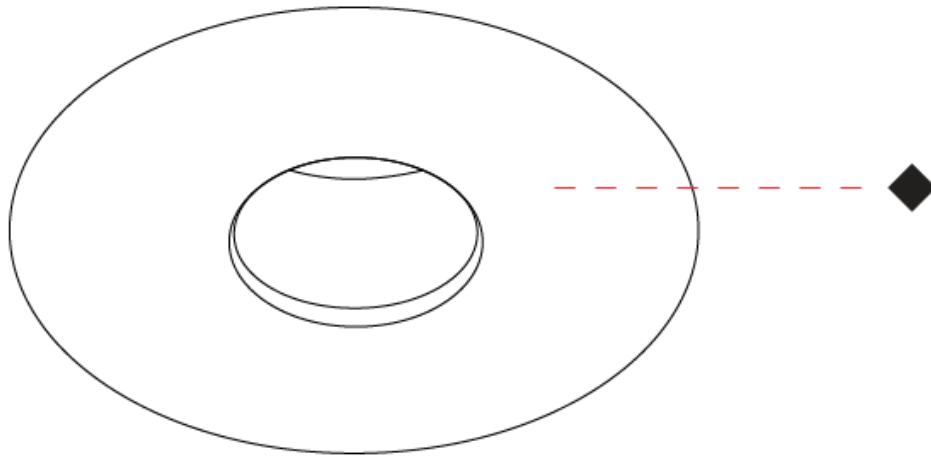

BIONIQ EVO ROUND PINHOLE TRIMLESS

A350223- -

base number Color Finishes
 Temperature (Diamond)

- To build a product code in our configurator select the specify button on the base model # product page
- To build a manual product code on this datasheet choose from the options listed below in blue font and add the suffix to the base model #

GENERAL

Series: Bioniq Evo Round Pinhole
 Partner: Prolicht
 Division: Architectural
 Installation: Trimless
 Product Type: Downlight
 Mounting Location: Ceiling
 Light Distribution: Adjustable / Direct

PHYSICAL

Shape: Round
 Diameter (mm): 95
 Diameter (in): 3 3/4
 Height (mm): 93
 Depth (mm): 105
 Height (in): 3 5/8
 Depth (in): 4 1/8
 Ceiling Thickness (mm): 10 - 50
 Ceiling Thickness (in): 3/8 - 1 15/16
 Weight (kg): 0.4
 Fixture Finish: [SSR / BKV / CWI / CRY / HAB / UFT / ITA / RUA / FTG / MYG / LOD / PUS / FRO / FUP / KIA / POP / BLS / SPG / MEY / GOH / CHC / COM / ABZ / JAG / OBR / MOS / ROR](#)
 Fixture Material: Extruded Aluminum
 Cut-out Measurements: Ø 75mm/2 15/16"

ELECTRICAL

Lamp Type: LED (Zhaga Standard)
 Input Wattage (W): 12.8
 Total Output Wattage (W): 11.8
 Dimming: Non-dimming / DALI Dimming / MATTER Dimming
 Driver Included: No
 Driver Location: Remote
 Driver Type: Constant Current - Universal
 Driver Class: Class 2
 Constant Current (MA): 350mA
 Upon Request: 0-10V Dimming / Phase Dimming

LED

Color Temperature (°K): [2400 / 2700 / 3000 / 3500 / 4000](#)
 Max. Delivered Lumen (lm): Max 604
 Nominal Lumen (lm): 1065
 CRI: >90 CRI
 Efficiency (%): 47.0
 Lamp Life (hrs): 50000

OPTICAL

Beam Angle: 10
 Adjustability: Rotational 350° / Tilt 30°

RATINGS AND CERTIFICATIONS

Certified By: Certified for North American Standards
 IP rating: IP65
 Glare Rating: ≤ 10

PROJECT
TYPE
SPECIFIER
QUANTITY
DATE

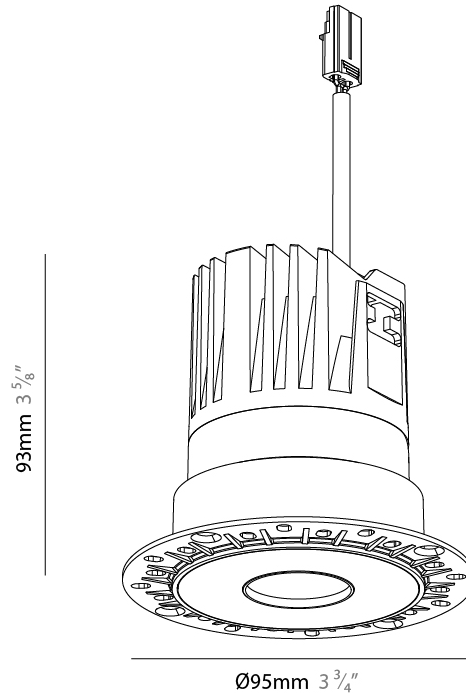
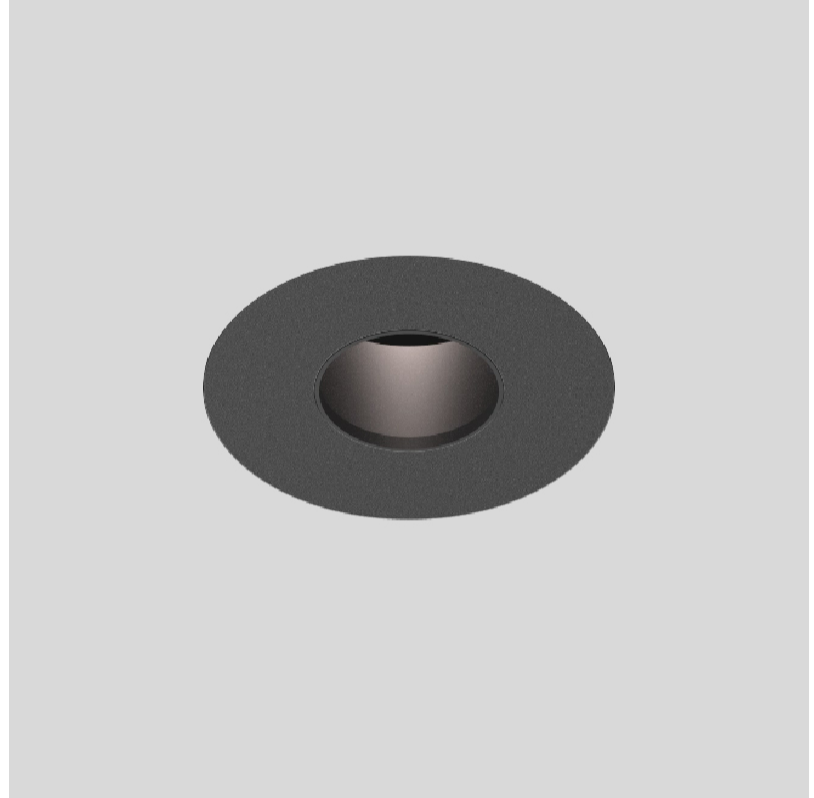

BIONIQ EVO ROUND PINHOLE TRIMLESS

A350223-

PROJECT	_____
TYPE	_____
SPECIFIER	_____
QUANTITY	_____
DATE	_____

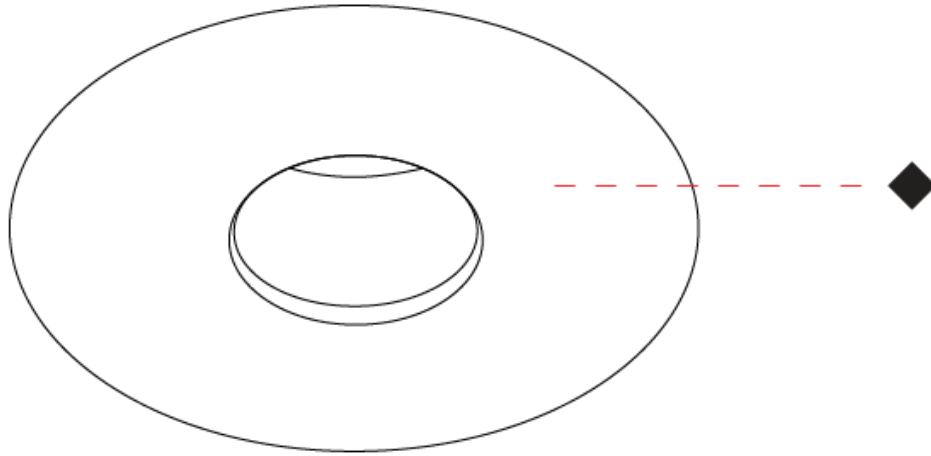

BIONIQ EVO ROUND PINHOLE TRIMLESS

A350224-

base number Finishes (Diamond) Beam Angle Options

- To build a product code in our configurator select the specify button on the base model # product page
- To build a manual product code on this datasheet choose from the options listed below in blue font and add the suffix to the base model #

GENERAL

Series: Bioniq Evo Round Pinhole
 Partner: Prolicht
 Division: Architectural
 Installation: Trimless
 Product Type: Downlight
 Mounting Location: Ceiling
 Light Distribution: Adjustable / Direct

PHYSICAL

Shape: Round
 Diameter (mm): 95
 Diameter (in): 3 3/4
 Height (mm): 93
 Depth (mm): 105
 Height (in): 3 5/8
 Depth (in): 4 1/8
 Ceiling Thickness (mm): 10 - 50
 Ceiling Thickness (in): 3/8 - 1 15/16
 Weight (kg): 0.4
[Fixture Finish: SSR / BKV / CWI / CRY / HAB / UFT / ITA / RUA / FTG / MYG / LOD / PUS / FRO / FUP / KIA / POP / BLS / SPG / MEY / GOH / CHC / COM / ABZ / JAG / OBR / MOS / ROR](#)
 Fixture Material: Extruded Aluminum
 Cut-out Measurements: Dia. 75mm/2 15/16"

ELECTRICAL

Lamp Type: LED (Zhaga Standard)
 Input Wattage (W): 12.8
 Total Output Wattage (W): 10.9
 Dimming: Non-dimming / DALI Dimming / MATTER Dimming
 Driver Included: No
 Driver Location: Remote
 Driver Type: Constant Current - Universal
 Driver Class: Class 2
 Constant Current (MA): 350mA
 Upon Request: 0-10V Dimming / Phase Dimming

LED

Color Temperature (°K): 2700-6500 Tunable White
 Max. Delivered Lumen (lm): Max 709
 Nominal Lumen (lm): 1495
 CRI: >90 CRI
 Efficiency (%): 57.5
 Lamp Life (hrs): 50000

OPTICAL

[Beam Angle: 20 / 26 / 32](#)
 Adjustability: Rotational 350° / Tilt 30°

RATINGS AND CERTIFICATIONS

Certified By: Certified for North American Standards
 IP rating: IP20
 Glare Rating: ≤ 10

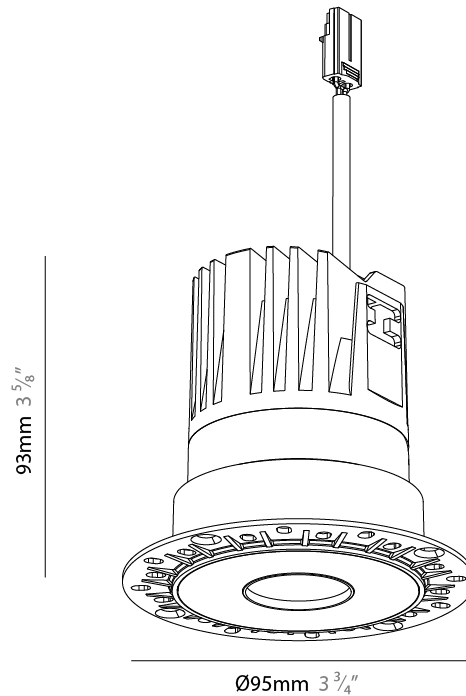
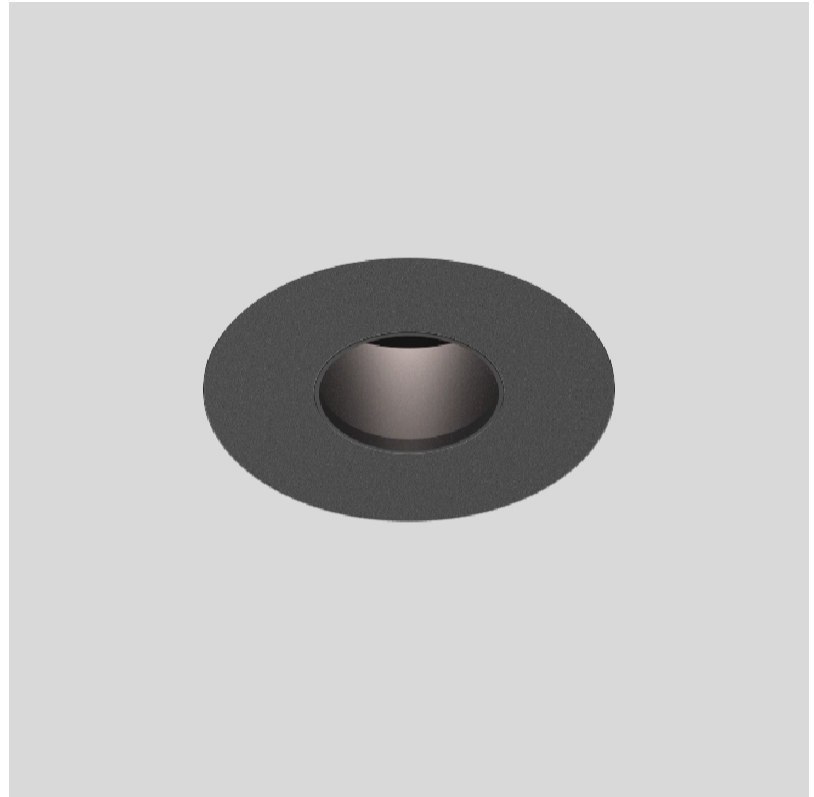

BIONIQ EVO ROUND PINHOLE TRIMLESS

A350224-

PROJECT	_____
TYPE	_____
SPECIFIER	_____
QUANTITY	_____
DATE	_____

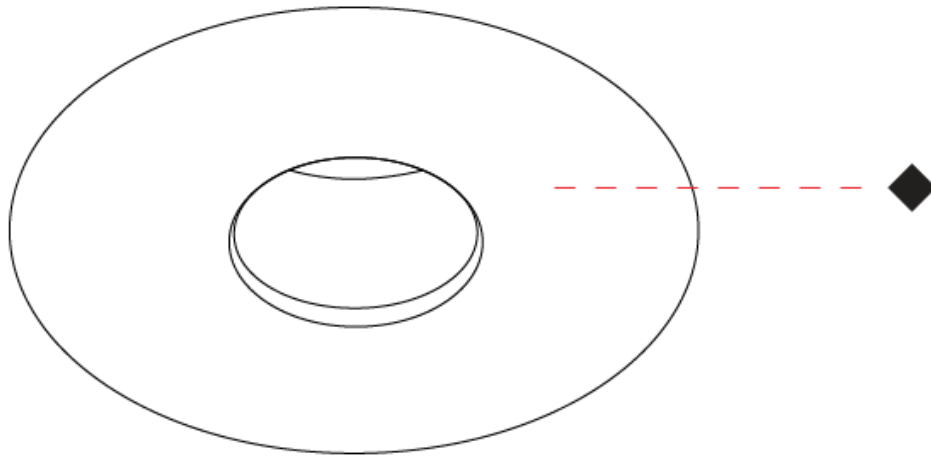

BIONIQ EVO ROUND PINHOLE COLOR FINISH CHART

PROJECT _____

TYPE _____

SPECIFIER _____

QUANTITY _____

DATE _____

Fixture Finish

Black - BLK (BLK)

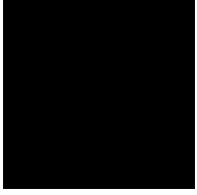

White - WHI (WHI)

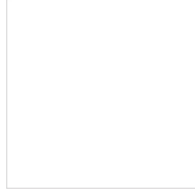

Sparkling Silver - 01 (SSR)



Black Velvet - 02 (BKV)

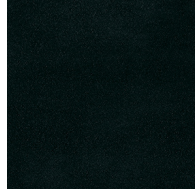

Crystal White - 03 (CWI)



Creamy - 04 (CRY)



Hampton Bay - 05 (HAB)



Urban Forest - 07 (UFT)



In the Army - 08 (ITA)

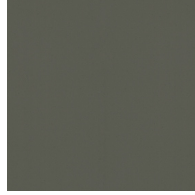

Rusty Angel - 09 (RUA)



Fade to Gray - 12 (FTG)



Mysterious Gray - 13 (MYG)



Lost Dream - 15 (LOD)

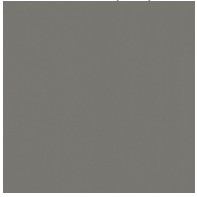

Purple Sky - 16 (PUS)

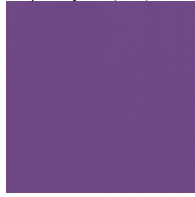

Fresh Oh - 17 (FRO)

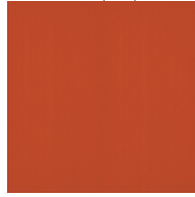

Funky P. - 18 (FUP)



Kissing Aphrodite - 19 (KIA)



Poseidon's Paradise - 20 (POP)



Blue Sky - 21 (BLS)



Spring Green - 22 (SPG)

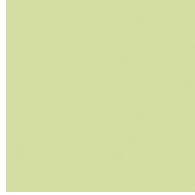

Mellow Yellow - 23 (MEY)

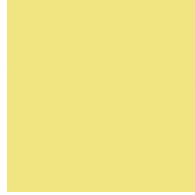

Golden Heart - 24 (GOH)



Champagne Cream - 26 (CHC)



Copper Mine - 27 (COM)



Ancient Bronze - 28 (ABZ)



Jazz Gold - 29 (JAG)



Olive Breeze - 30 (OBR)



Moonlight Silver - 31 (MOS)



Rosewood Red - 32 (ROR)



Digital: Not all screens are calibrated the same, and therefore, colors will appear differently between screens.

Physical: When texture is involved, there will be variations in color, character and tone within a product series and between product families.

Champagne Cream, Copper Mine, Ancient Bronze + Jazz Gold: These finishes have slight fading from specific powder coating production. Each luminaire will slightly vary.



LEGEND

	floor-mounted		pivotal		special LED (upon request) RGB, RGBW, tunable, gold+, meat+, art+, fashion+
	wall and ceiling: recessed and surface mounted		rotating		warm dim / natural dimming LED
	ceiling-mounted and wall-mounted		illuminate tilted		rechargeable battery powered
	wall-mounted		color of suspension cable		fixture with natural vivid LED (upon request)
	omni-directional light distribution		length of suspension cable		color rendering index
	direct light distribution		reflector degree selection		color temperature
	direct/indirect light distribution		super spot		lumen (luminous flux)
	indirect light distribution		lens		efficacy (lumens per watt)
	asymmetric light distribution		lens pack		Unified Glare Rating (UGR) range from 5-40
	aura light distribution		shine ring		marine grade (AISI 316 stainless steel)
	round wall or ceiling cut-out		integrated shine ring with diffuser		walk on
	square wall or ceiling cut-out		free individual colors 01-29		drive on
	the supplied jig specifies the cutout dimensions		individual colors: 00 (free of charge), 01-25 (extra charge)		Dark Sky Compliance
	minimum distance (meters) lamp - object		luminaire part to be colored (F1)		Americans with Disabilities Act (less than 4" off the wall located between 27"-84" from floor)
	recessed depth		luminaire part to be colored (F2)		lamp protected against explosion
	ceiling thickness in mm		luminaire part to be colored (F3)		blown glass using traditional methods by master glass blower
	ceiling thickness selection		luminaire part to be colored (F4)		acoustic material
	dimnable DP (phase), DV (0-10V), DD (dali), DS (step-dim)		luminaire part to be colored (F5)		protection class I, protection insulation
	included or excluded LED driver/transformer/control gear		color of 3-circuit adaptor		protection class II, protection insulation
	separately switchable		indirect diffuser		ETL Certified to UL and CSA Standards
	sensor		direct diffuser		UL Certified to UL and CSA Standards
	remote control		ball-proof (upon request)		CSA Certified to UL and CSA Standards
	available upon request		accessory		Certified for North American Standards

IP RATING

	protected against ingress of solid bodies greater than 12.5mm (finger)
	protected against ingress of solid bodies greater than 2.5mm protected against sprays of water up to 60 degrees from the vertical (rain)
	protected against ingress of solid bodies greater than 1mm (wire) no protection against the ingress of moisture
	protected against ingress of solid bodies greater than 1mm (wire) protected against sprays of water up to 60 degrees from the vertical (rain)
	protected against ingress of solid bodies greater than 1mm (wire) protected against water splashed from all directions
	protected against limited ingress of dust (wet rooms/covered outdoor areas) protected against water splashed from all directions
	protected against ingress of dust protected against jets of water
	protected against ingress of dust protected against powerful jets of water or heavy seas
	protected against ingress of dust protected against immersion of water between 15cm - 1m for 30 minutes
	protected against ingress of dust protected against immersion of water under pressure for long periods

IK RATING

	protected against 0.14 joules impact (equivalent to 0.25kg mass dropped from 56mm above the surface)
	protected against 0.2 joules impact (equivalent to 0.25kg mass dropped from 80mm above the surface)
	protected against 0.35 joules impact (equivalent to 0.25kg mass dropped from 140mm above the surface)
	protected against 0.5 joules impact (equivalent to 0.25kg mass dropped from 200mm above the surface)
	protected against 0.7 joules impact (equivalent to 0.25kg mass dropped from 280mm above the surface)
	protected against 1 joules impact (equivalent to 0.25kg mass dropped from 400mm above the surface)
	protected against 2 joules impact (equivalent to 0.5kg mass dropped from 400mm above the surface)
	protected against 5 joules impact (equivalent to 1.7kg mass dropped from 300mm above the surface)
	protected against 10 joules impact (equivalent to 5.0kg mass dropped from 200mm above the surface)
	protected against 20 joules impact (equivalent to 5.0kg mass dropped from 400mm above the surface)